

SUPPORT



Package content:

Supports up to 15kg
33 lb

- 04 S-10 plastic bushings;
- 04 superb hexagonal screws 5/16 x 50 mm;
- 02 hexagonal screws M6 x 16 mm;
- 02 hexagonal screws M6 x 45 mm;
- 02 M6 locking nuts;
- 06 6 mm flat washers.

Installation with fixing support

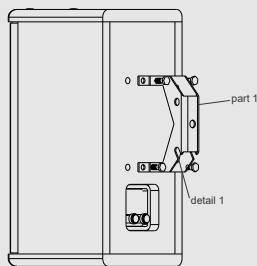
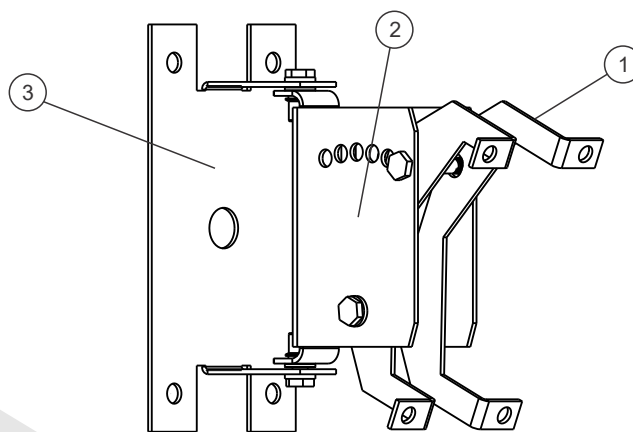

Image 1;

1st STEP

Screw part 1 into the passive box with **detail 1** positioned downwards, as shown in image 1.

Use the screws that are attached to the back of the box.

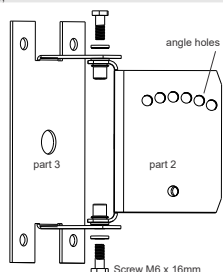

Image 2;

2nd STEP

Screw part 2 together with part 3, so that the **angle holes** are upwards, as shown in image 2.

Use 2 washers and 2 M6 x 16mm screws

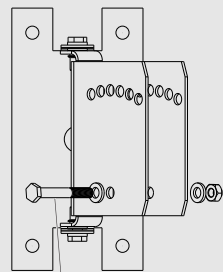

Image 3;

3rd STEP

Screw the support to the wall, using 4 hexagonal screws 5/16 x 50 mm + 4 plastic anchors.

Insert the screw in part 2 as shown in image 3, this screw will be used to receive the passive box.

Use 2 washers, 1 M6 x 45mm screw and 1 M6 nut.

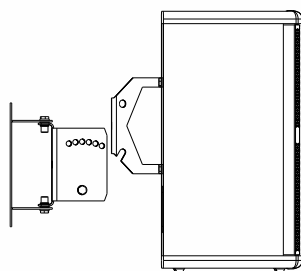

Image 4;

4th STEP

Position your passive box next to the support already on the wall and adjust the desired inclination.

Each support position is equivalent to 8 degrees of inclination

Use 2 washers, 1 M6 x 45mm screw and 1 M6 nut.

Maximum inclines

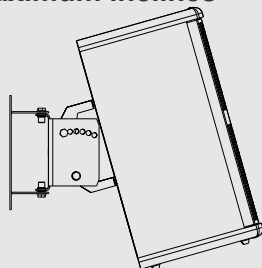

-16 Degrees

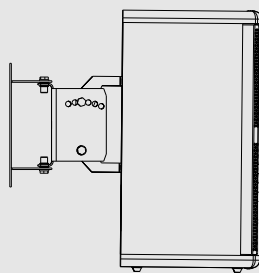

0 Degree

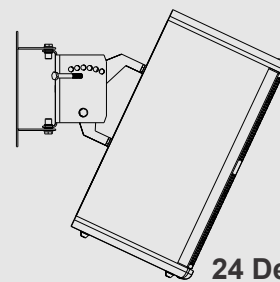

24 Degrees

NOTE: Features, specifications and aesthetic aspects are subject to change without prior notice.

Manufactured by: TARAMPS ELECTRONICS LTDA - TAX ID: 11.273.485/0001-03 - KM 30 Júlio Bidisk Hwy, Da pedreira Neighborhood, Alfredo Marcondes, SP - 19180-000, Brasil - Made in Brazil

+55 18 3266-4050

www.taramps.com.br